

Brännbart loft

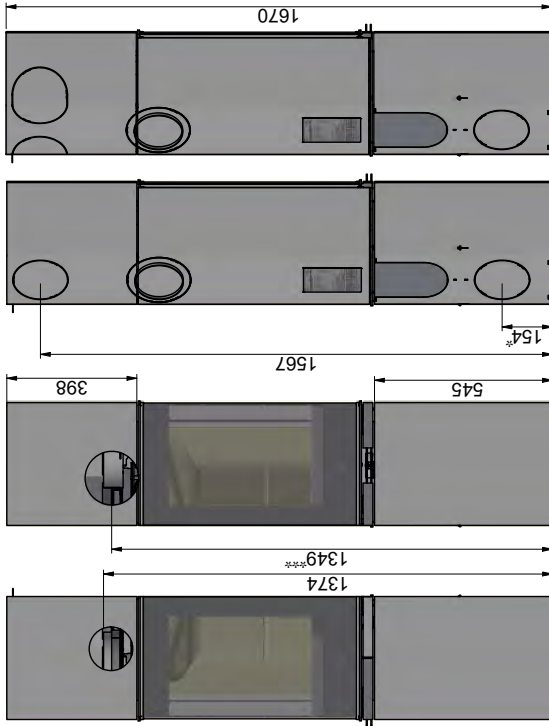

Scanspis 80-3 och Scanspis 80-4



Scanspis 80-1 och Scanspis 80-2

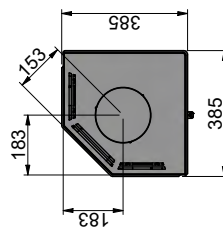
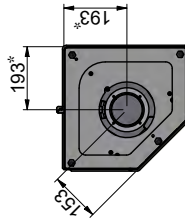
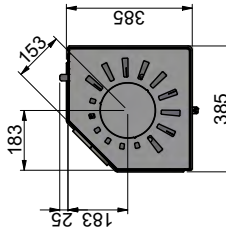
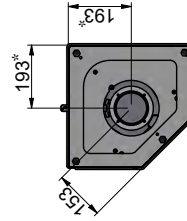
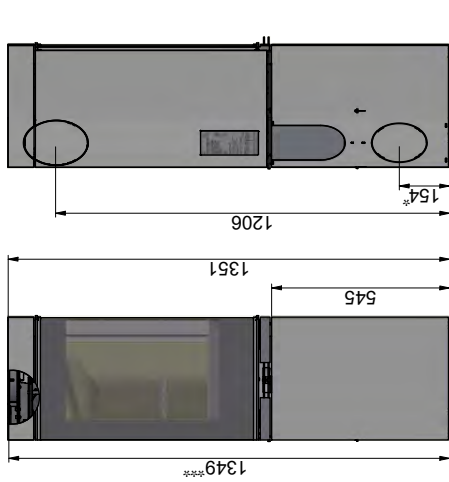

Golvplatta

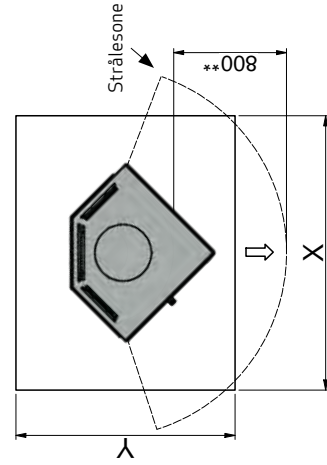

Samtliga mått anges i mm  
 Samtliga angivna avstånd är minimimått  
 \* Frisklufttillförsel - utv. diameter Ø 100 mm  
 \*\* Min. avstånd til möbler/brännbart material  
 \*\*\* Höjd till rökrorets start vid toppavgång

X/Y - enligt nationellt gällande lagar och regler